

Određivanje vrijednosti otpornika na osnovu boja

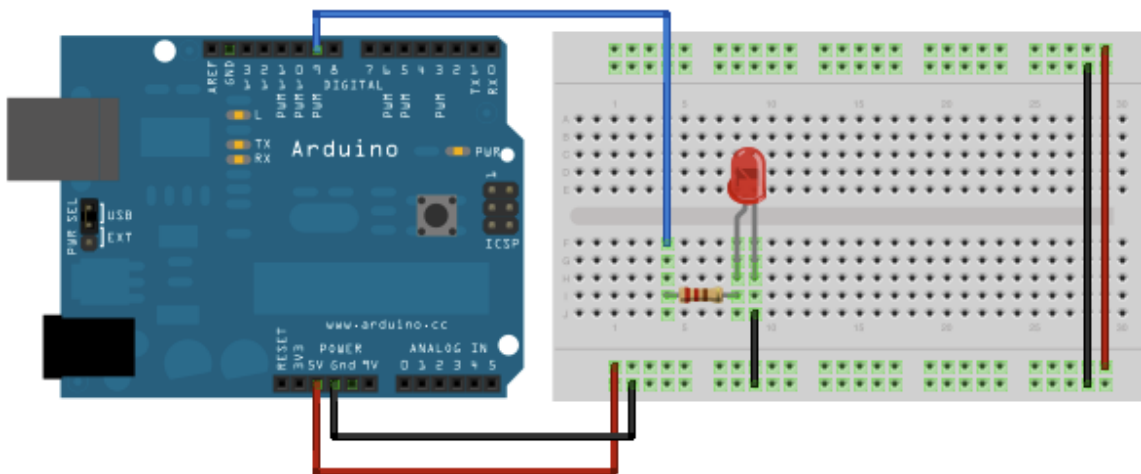

LED svjetleća dioda
(otpornik $\leq 300\Omega$)

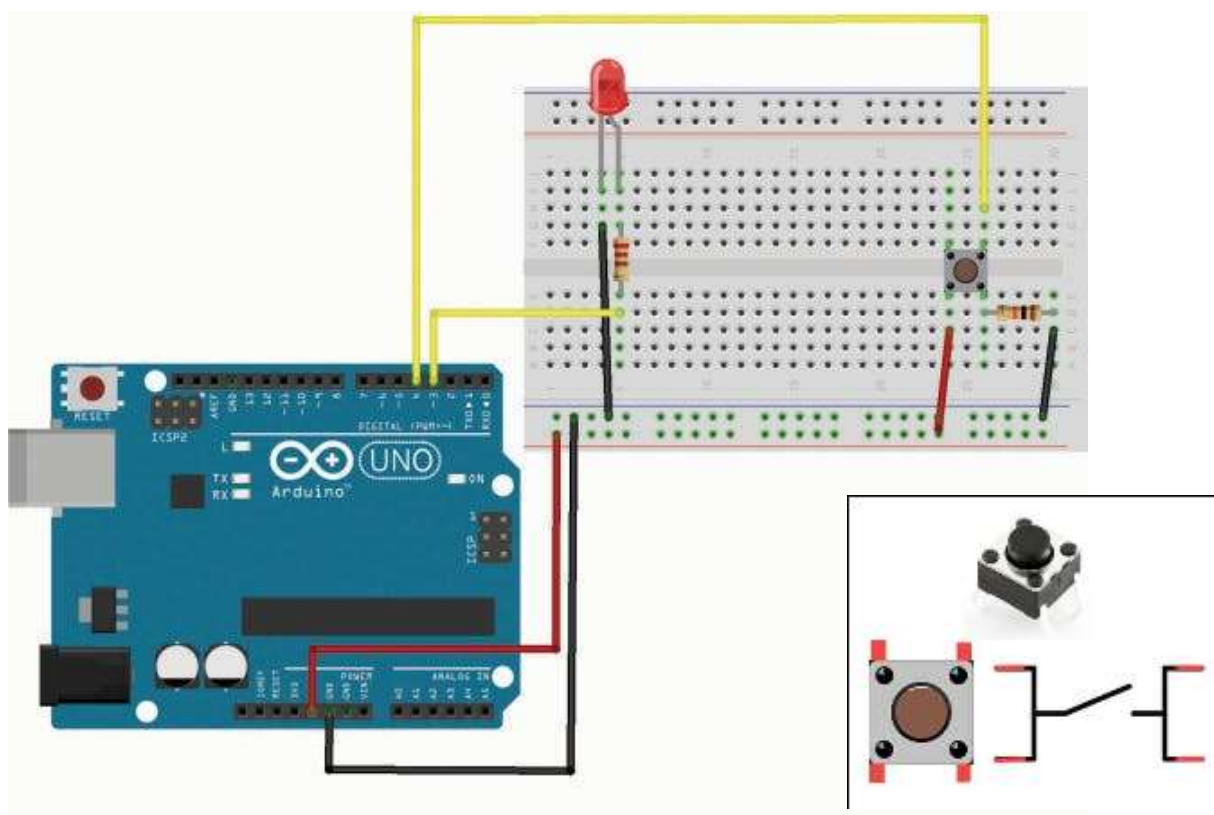

Kontrola LED diode pomoću 4-pinskog prekidača (digitalni ulazni pinovi)
(otpornik uz diodu $\leq 300\Omega$ a otpornik uz prekidač $10k\Omega$)

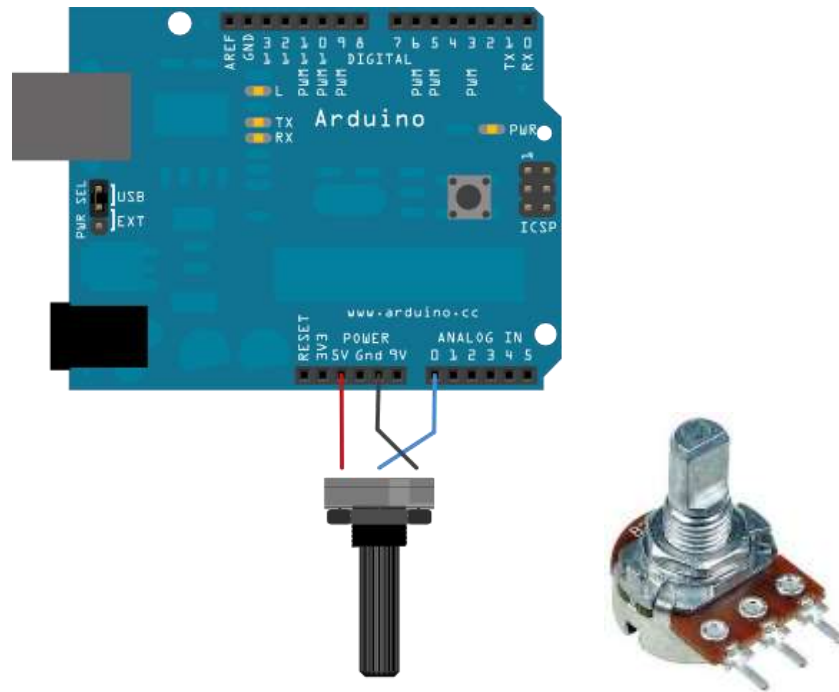

Spajanje potencijometra na analogne ulazne pinove

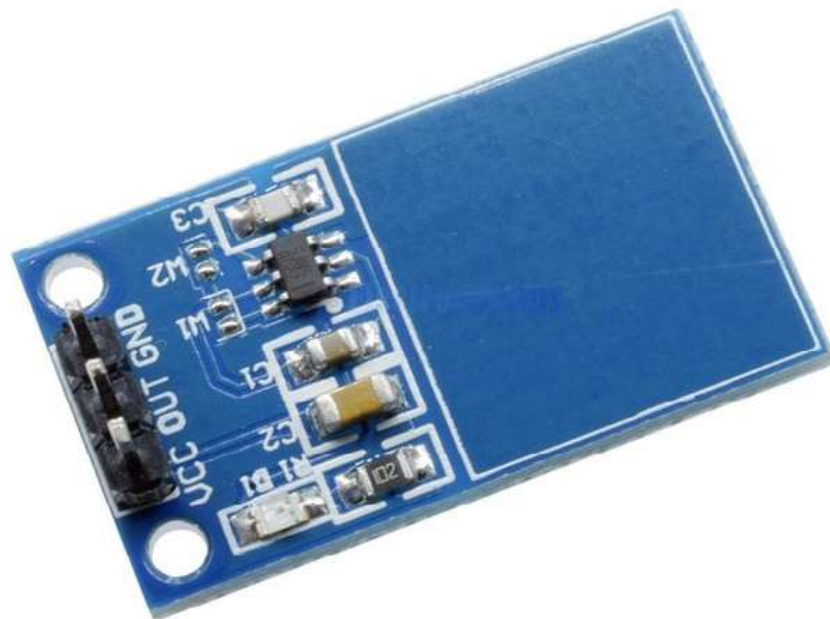

Spajanje kapacitivnog senzora dodira (OUT - digitalni ulazni pin)

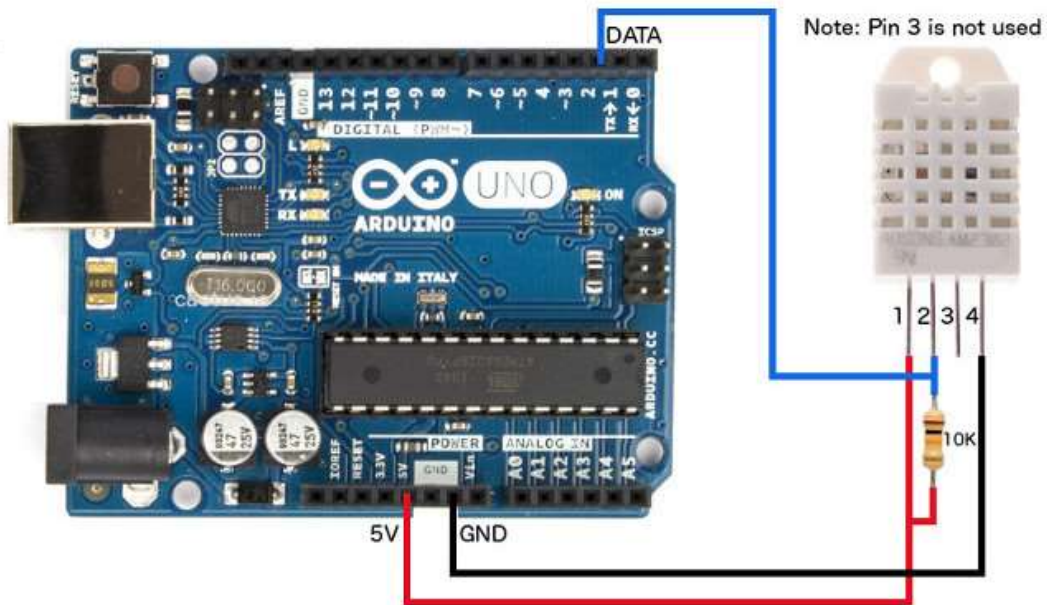

DHT22 senzor za mjerenje temperature i vlažnosti vazduha

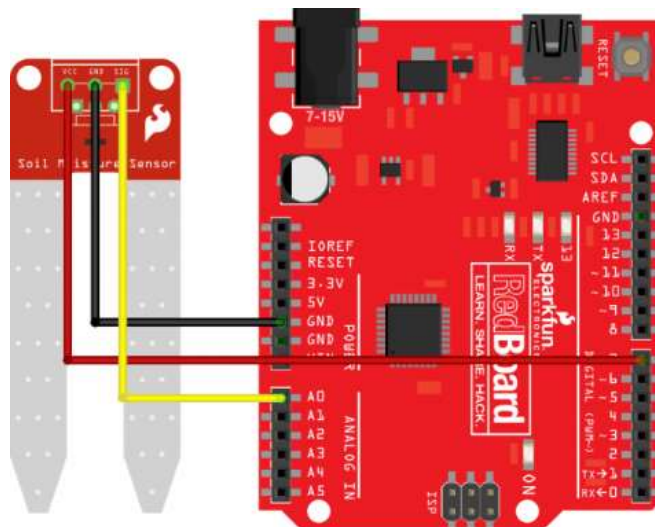

Senzor za mjerenje vlažnosti zemljišta

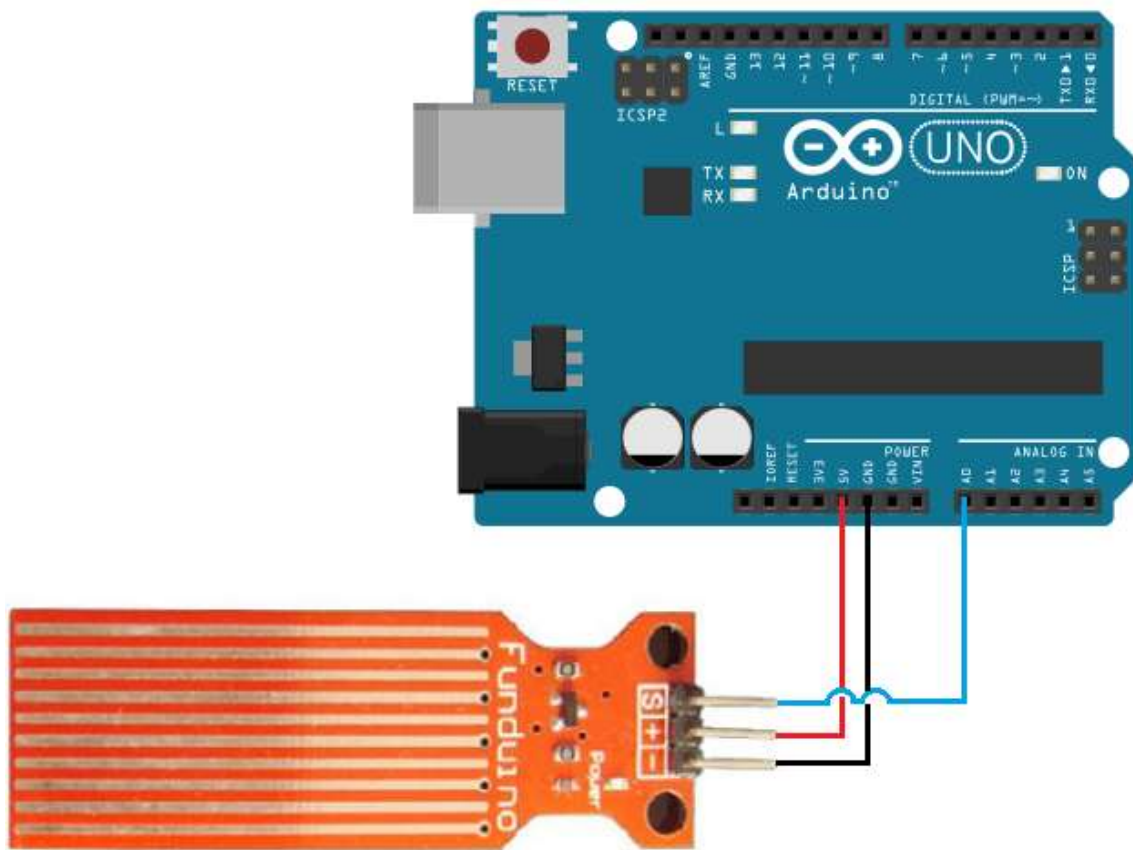

Senzor za mjerenje količine vlažnosti (detektor vode)

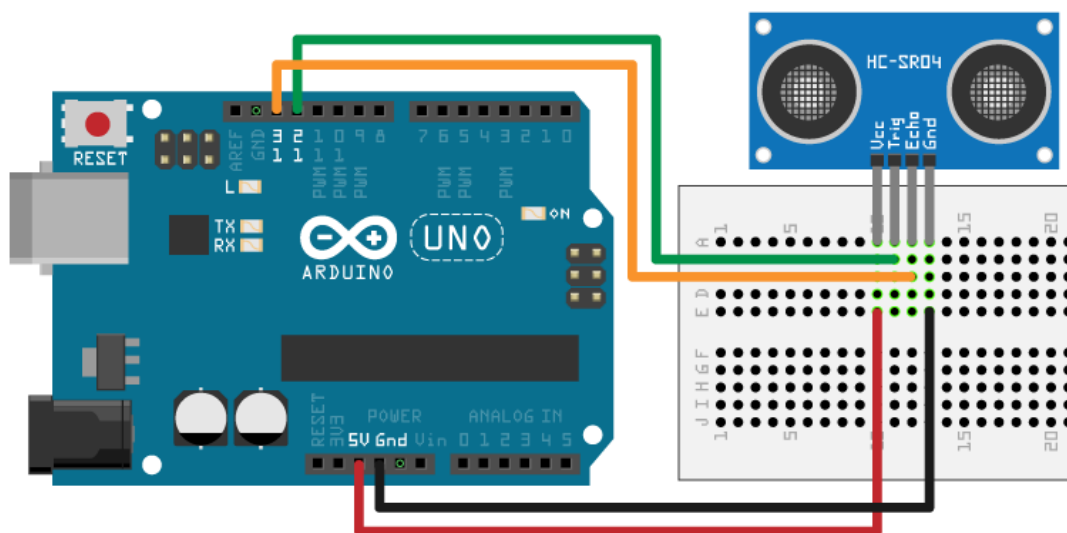

Senzor za mjerenje distance objekta



Senzor za mjerenje kvaliteta vazduha (ulazni analogni pin)

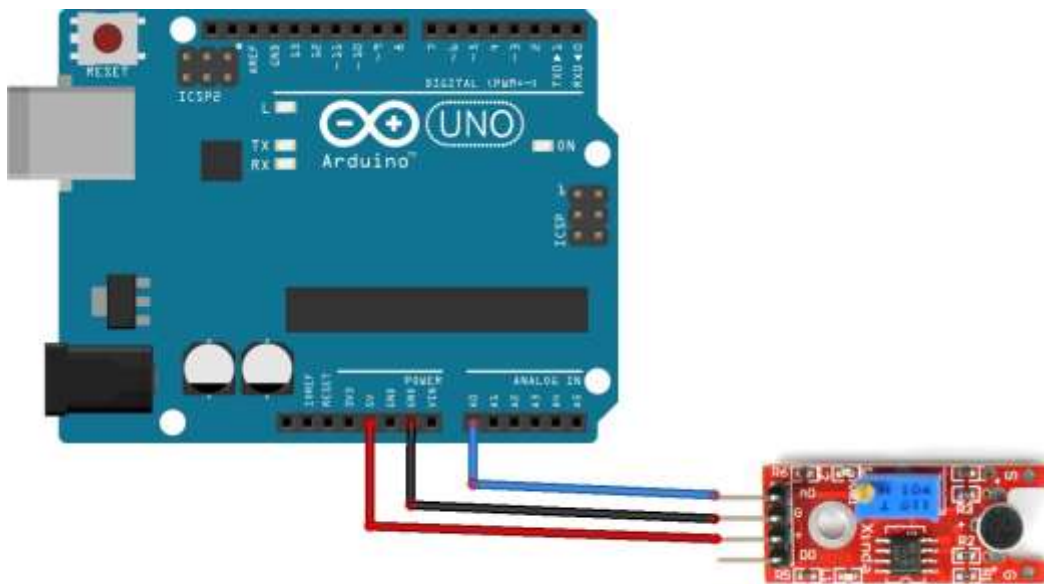

Senzor za mjerenje jačine zvuka (mikrofon)

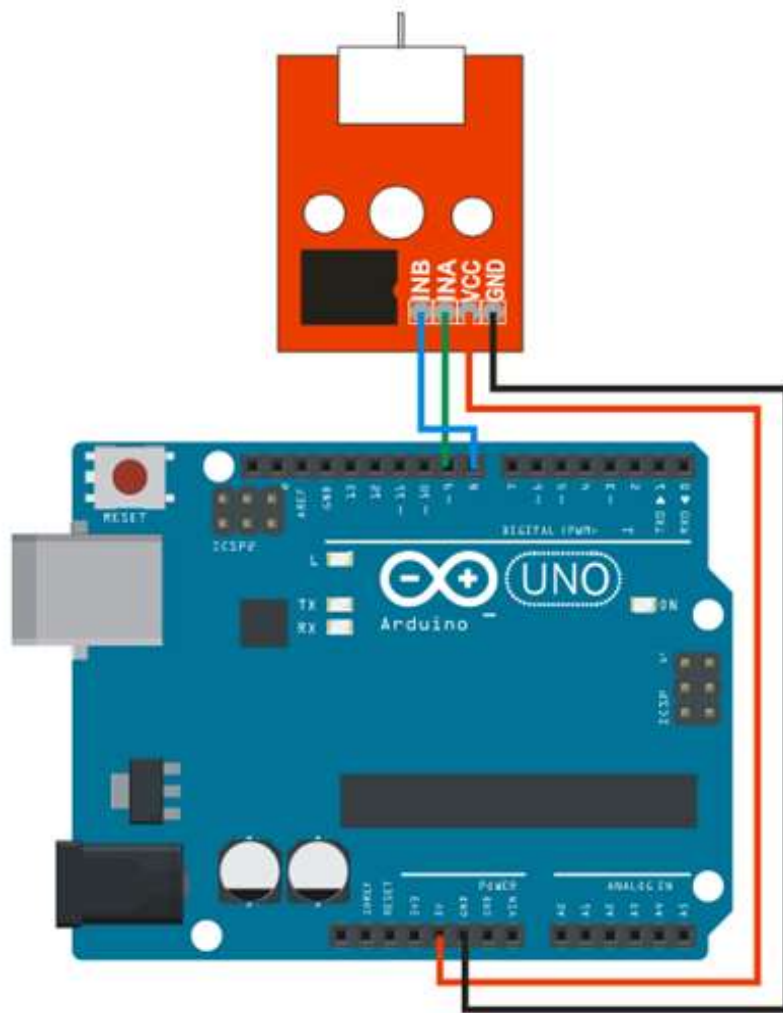

Šema spajanja motora (propelera)